

**SERVER**

• E S S E N T I A L S •

## Syrup Server

MODEL: SY 1.5

**85480 UNIT**  
**1½ GALLON SERVER**

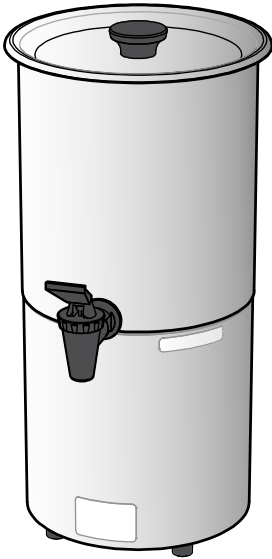

MODEL: SY

**84190 UNIT**  
**3 GALLON SERVER**

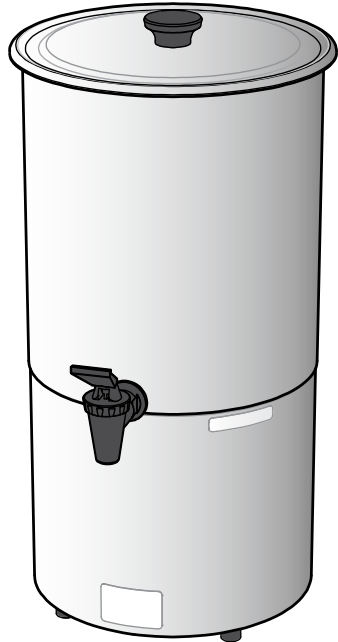

***Thank You***

for purchasing this Syrup Server  
to heat and neatly dispense sticky syrups  
and sauces.

WARM & SERVE SYRUP—SIMPLY!

# PARTS

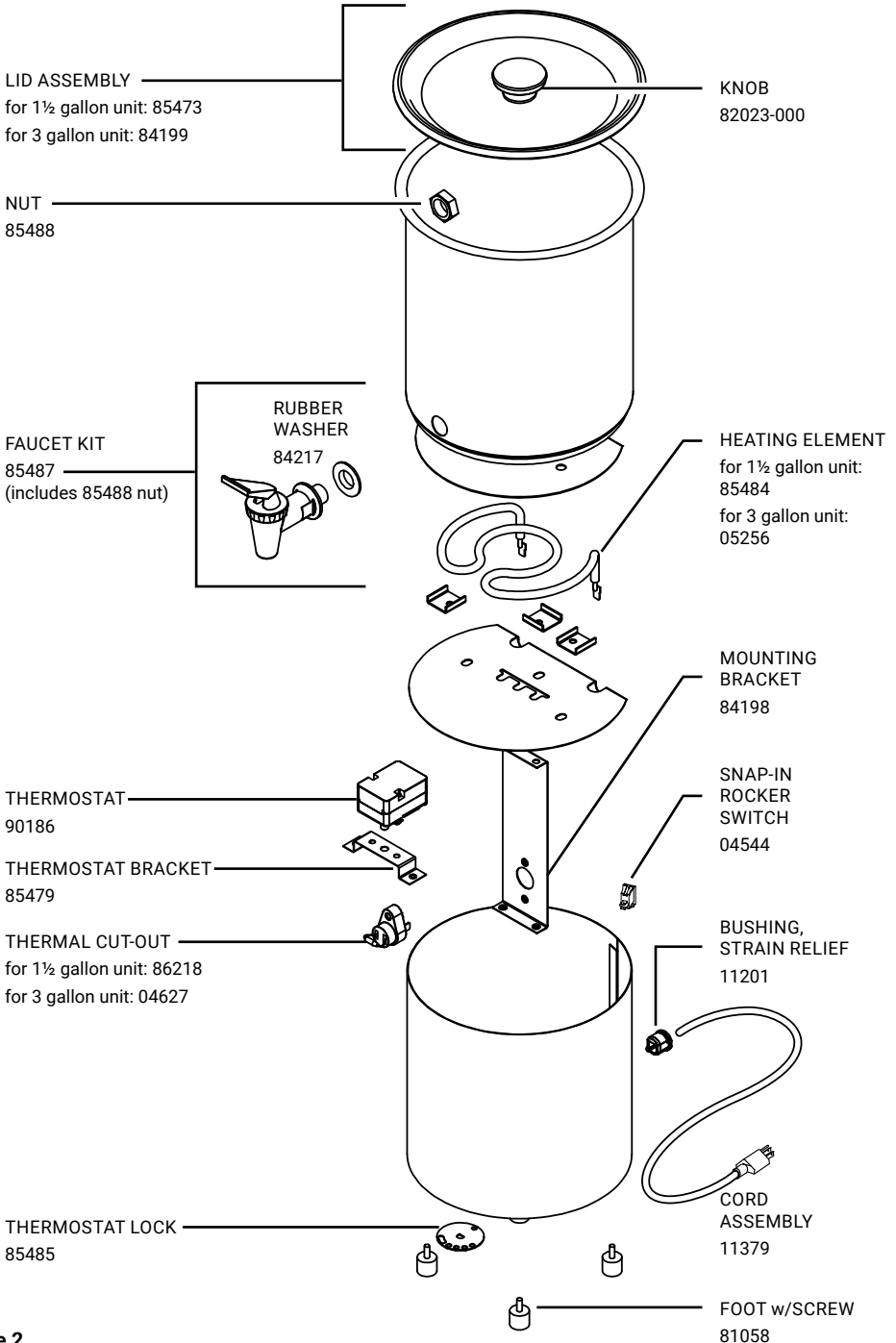

# FAUCET ASSEMBLY

WASH ALL PARTS PROPERLY  
BEFORE EVERY USE. See page 6.

- 1** INSERT CUP SEAT  
into faucet.

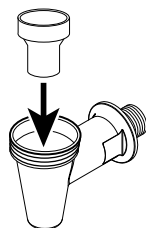

- 2** INSTALL TOP  
onto faucet.

**TIP:** Lubricate threads with a small amount  
of clean water.

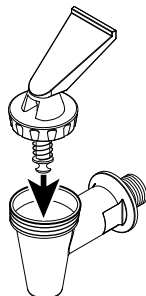

- 3** ROTATE TOP CLOCKWISE  
to secure.

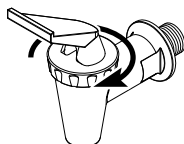

- 4** INSTALL WASHER  
onto threaded shank of faucet.

**IMPORTANT:**

- Flat side of washer must face faucet.
- Round side of washer must face away  
from faucet.

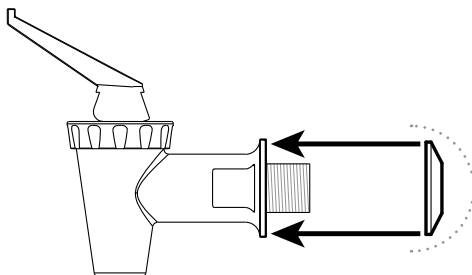
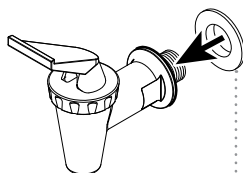

# UNIT SETUP

WASH ALL PARTS PROPERLY  
BEFORE EVERY USE. See page 6.

See page 4 for FAUCET ASSEMBLY

- 1** INSTALL FAUCET  
into hole.  
Attach nut to faucet from inside vessel.

## YES

- Round side of washer seals inside hole.
- Tighten nut until snug.

## NO

- Flat side of washer must not face hole.
- Do not over-tighten nut.

*Overtightened nut will strip threads  
and cause washer to leak.  
Overtightened nut will flatten washer  
and cause leak.*

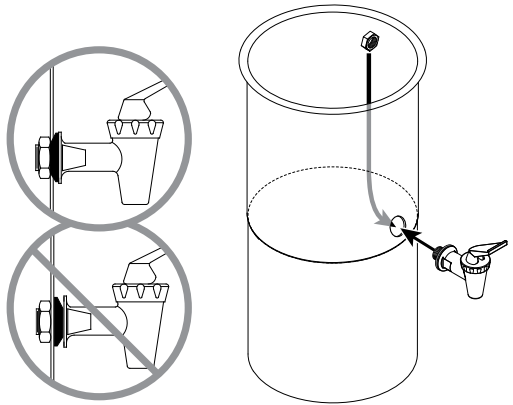

- 2** ADD PRODUCT & LID

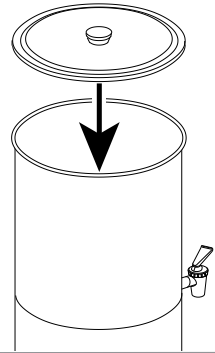

- 3** PLUG CORD into power source.

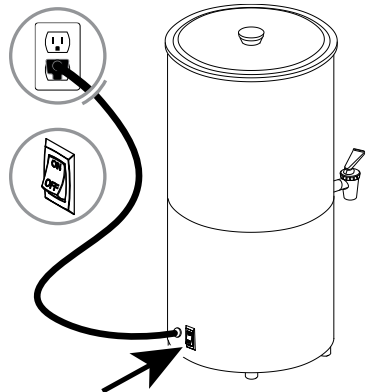

- 4** PRESS SWITCH to the "ON" position.

*To adjust TEMPERATURE SETTING,  
see page 7.*

# UNIT TAKE-DOWN

**1** PRESS SWITCH to the "OFF" position.

**2** UNPLUG CORD



**CAUTION- HOT**

Allow unit to cool before continuing or use proper care with hot surfaces.

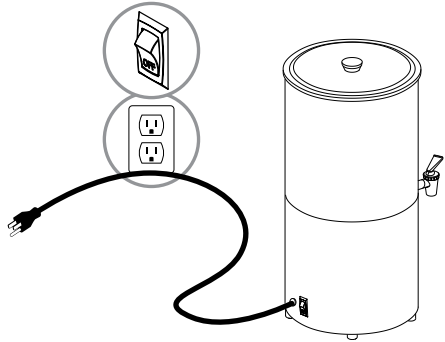

**3** REMOVE LID

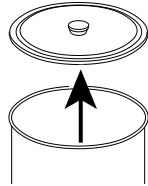

**4** EMPTY ANY REMAINING PRODUCT from vessel.

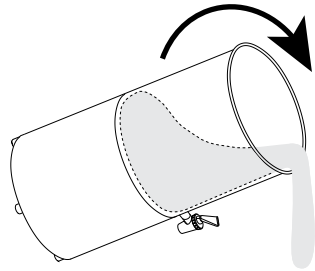

**5** REMOVE FAUCET  
Unscrew nut from inside vessel.

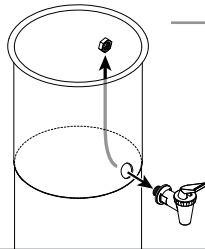

**6** DISASSEMBLE FAUCET  
Take apart all four pieces.

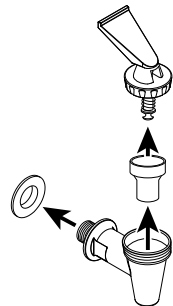

**IMPORTANT:**  
**PREVENT DRIPPING**

*Disassemble and clean faucet daily.*

# SAFETY



## WARNING-

### ELECTRICAL SHOCK COULD OCCUR

This unit must be earthed or grounded.

This requires all three prongs (terminals) on cord plug to be plugged into power source.



According to food and safety regulations, most foods must be stored and/or served at certain temperatures or they could become hazardous. Check with local food and safety regulators for specific guidelines.

**Be aware of the product you are serving and the temperature the product is required to maintain. Server Products, Inc. can not be responsible for the serving of potentially hazardous product.**

# CLEANING



## WARNING-

### ELECTRICAL SHOCK COULD OCCUR

- Electrical components of unit could be damaged from water exposure or any liquid.
- Never immerse unit into water or any liquid.
- Never use any water jet or pressure sprayer on unit.
- Ensure unit is "OFF" and unplugged.

## CAUTION- HOT

Allow unit to cool before cleaning.



### CLEAN EXTERNAL SURFACES

- Wipe daily with a clean damp cloth.
- Dry with a clean soft cloth.
- Glass and surface cleaners approved for use in food contact areas may be used.



- 1 CLEAN**  
After disassembling, thoroughly clean all washable parts with soap and hot water.
- 2 RINSE** fully with clear water.
- 3 SANITIZE**  
all parts according to local sanitization requirements. All parts in contact with food must be sanitized.
- 4 DRY**  
Air dry faucet parts fully.  
Dry stainless steel with clean, soft cloth.

# CARE OF STAINLESS STEEL

This syrup server is constructed of stainless steel— one of the best materials for food serving and storage.

If you notice corrosion beginning on any stainless steel surface, you may need to change the cleansing agent, sanitizing agent, or the cleaning procedures you are using.

- A mildly abrasive nylon or brass brush may be used to remove any stubborn food or mineral deposits on interior surfaces of unit.
- Fully rinsing and drying all parts can help prevent corrosion. Elements and minerals in tap water can accumulate on stainless steel parts and create corrosion.
- Do not use abrasive, caustic or ammonia based cleansers.
- Do not use products containing acids, alkalines, chlorine, or salt. These agents can corrode stainless steel.
- Do not use metal scrapers or cleaning pads that could scratch surfaces.

# WIRING

UNITS 85480 & 84190 | 120V | USA

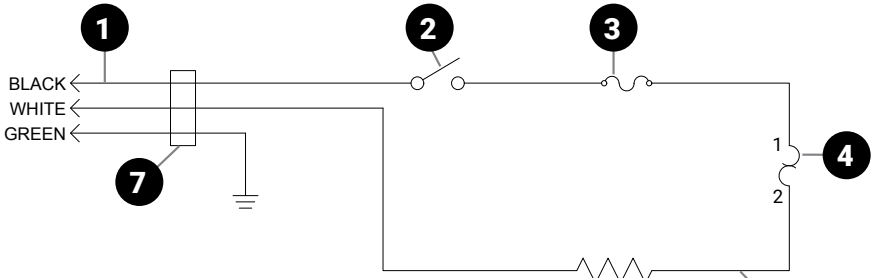

- 1** Cord Assembly
- 2** Snap-In Rocker Switch
- 3** Thermal Cut-Out
- 4** Thermostat
- 5** Wire Assembly
- 6** Heating Element
- 7** Bushing, Strain Relief

# TEMPERATURE SETTING

Thermostat is preset at 140 °F.....

Temperature setting is adjustable in 20 °F increments from 80 °F–180 °F.\*

## To change setting: ADJUST THERMOSTAT LOCK

**Vessel must be empty.  
Set unit upside down.**

- 1** REMOVE SCREW from lock.
- 2** ROTATE LOCK to desired temperature.
- 3** SECURE THERMOSTAT LOCK with screw to set temperature.

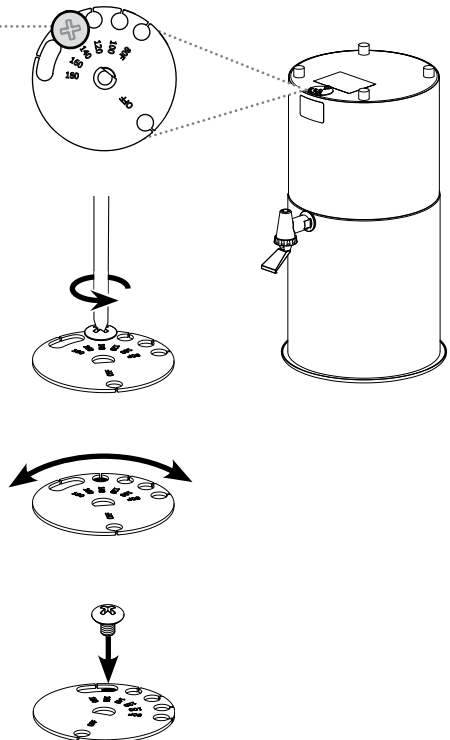

\*Temperature is preset at 60 °C.  
Setting is adjustable in 11 °C increments  
from 26.6 °C–82.2 °C.

# TROUBLESHOOTING

## UNIT DOES NOT HEAT?

- Ensure cord is securely plugged in.
- Ensure unit is on.
- Ensure thermostat lock is set correctly.
- Ensure power is available from source.
- Do not allow any of the electrical components to get wet. Moisture may cause the unit to trip breaker or GCFI. If moisture is suspected, discontinue use. Allow unit to fully air dry.

## FAUCET LEAKS?

- Fully disassemble and clean faucet daily.
- Ensure that washer is installed with flat side towards faucet.

### YES

- Round side of washer seals inside hole.
- Tighten nut until snug.

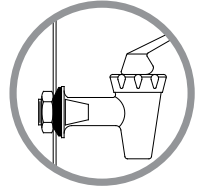

### NO

- Flat side of washer must not face hole.
- Do not over-tighten nut.  
*Overtightened nut will strip threads and cause washer to leak.*  
*Overtightened nut will flatten washer and cause leak.*

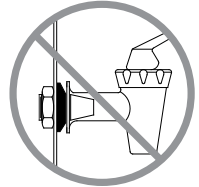

## SERVER PRODUCTS LIMITED WARRANTY

**2** YEAR  
WARRANTY

This Server product is backed by a two-year limited warranty against defects in materials and workmanship. See [Server-Products.com](http://Server-Products.com) for details.

## GENERAL SERVICE, REPAIR OR RETURNS

Before sending any item to Server Products for service, repair, or return, contact Server Products customer service to request a **Return Authorization Number**. Merchandise must be sent to Server Products with this number. Service is extremely prompt. Typically, units are repaired and ship out within 48 hours of receipt.

Merchandise being returned for credit must be in new and unused condition and not more than 90 days old and will be subject to a 20% restocking charge. Electrical parts (thermostats, heating elements, etc.) are not returnable.

**Servicing Cord:** Specific tools are required for safe and proper power supply cord removal and installation. If cord must be replaced, only a representative of the OEM (original equipment manufacturer) or a qualified technician may replace cord. Cord must meet code designation H05 RN-F requirements.

## NEED HELP?

**Server Products Inc.**  
3601 Pleasant Hill Road  
Richfield, WI 53076 USA

**Chat with us!**  
[spsales@server-products.com](mailto:spsales@server-products.com)  
262.628.5600 | 800.558.8722

Please be prepared with your **Model, P/N** and **Series** located on the lid or base of the unit.

Example: 

MODEL XXXX P/N #####		SERIES ##X ##X
-------------------------------	---	-------------------

**SERVER**  
INTELLIGENT BY DESIGN